

QUICK START

Debut HUB is a powerful device normally used as a network gateway. With GNSS, network communication modules, multiple sensors, flexible power-supply sources, and Druid's patented INTELINK technology, it is usually used in the wild field to provide network communication for other Debut devices, monitor colony entry/exit behaviors, and search for lost devices.

System Architecture

The flow-chart below shows how HUB functions as a gateway for communication between Debut devices and cloud server via cellular network. And you can also use your mobile phone to perform real-time operations on other Debut devices via HUB.

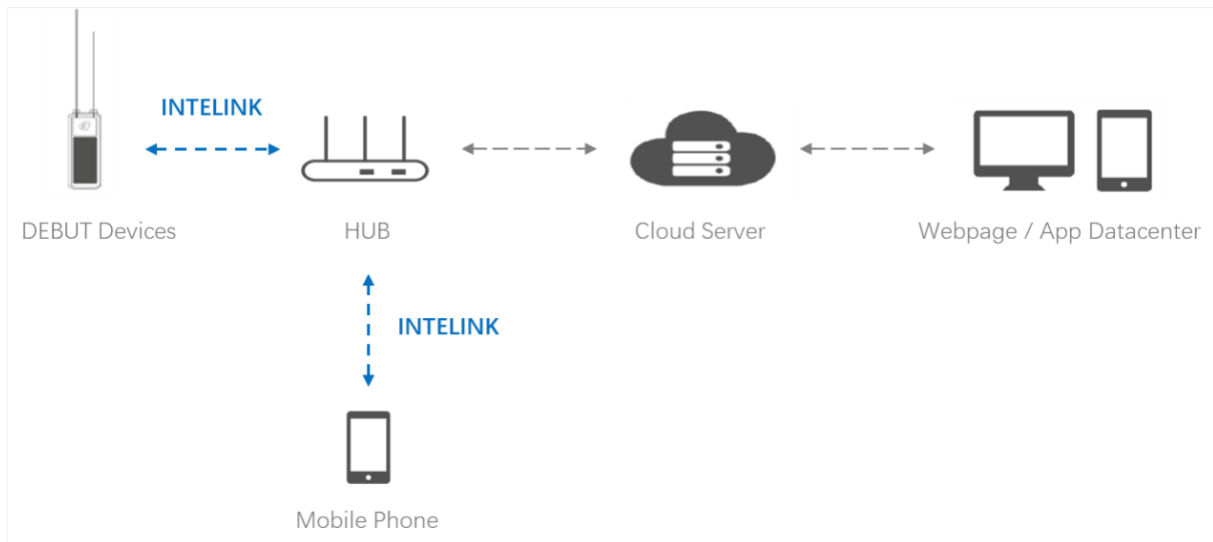

Before Using

Make sure you have an Ecotopia account to log in to Ecotopia App and data center.

- Ecotopia App: Search "Ecotopia" on App Store or Google Play. This is the App logo: 
- Ecotopia data center: <https://www.ecotopiago.com/#/login>

You can operate all devices under the account after logging in.



Before test, please switch the data service status from the default "Suspended" to "Active" and subscribe additional data including **ODBA** data if you need.

¹ This QSG also applies to Debut TAG G series, which is of the same function as HUB, unless otherwise specified.

Getting Started

Step 1: Assign Devices to HUB

Log in to Ecotopia data center, and click “**Device** -> **Gateway**” from the left sidebar menu.

Here you will see your gateway device list including HUB. Click  icon on the right side of the list to enter terminal device list page. Then click  to choose the devices to assign to HUB.

Note:

- To protect privacy, HUB can only communicate with devices assigned to it.
- You can assign one device to multiple HUBs.

Step 2: Install Antennas for HUB

Install the three antennas for HUB as shown below.

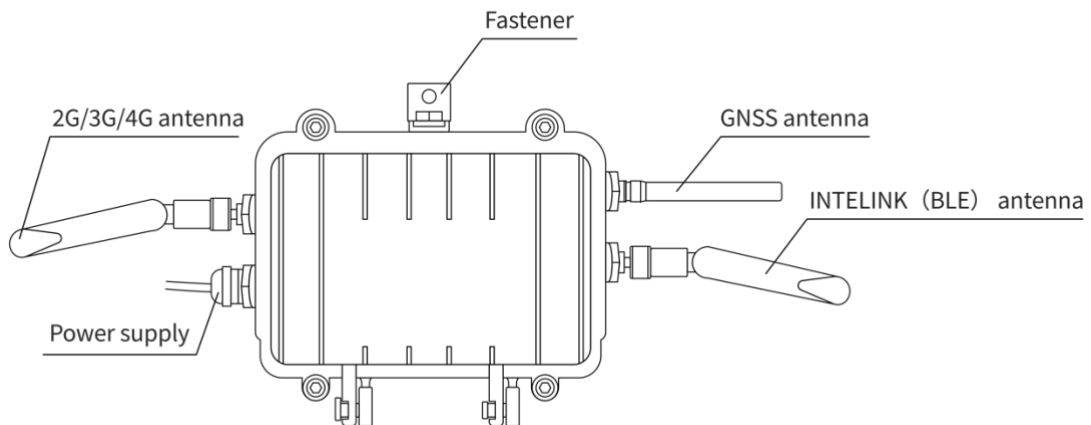

Note:

- This step is not needed for Debut TAG G.
- For some batches, the 2G/3G/4G antenna is labeled as NB/4G or TXGN-JKD-20, and INTELINK (BLE) antenna is labeled as WIFI or TX2400-JKD-20.
- Mind the orientation of male and female connectors (as shown below) when connecting solar panel to the HUB.
- Before placing the HUB in the field, it is suggested to seal the joint part with 706 silica gel and wrap it with electrical tape to avoid possible water penetration.

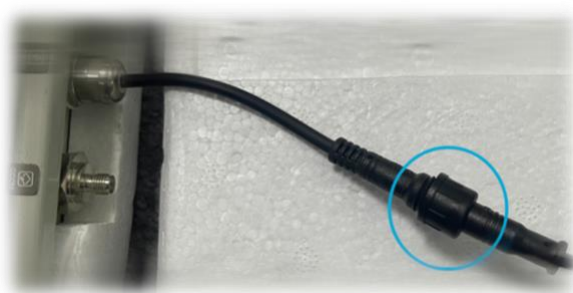

Step 3: Turn On HUB and Deliver Settings

It is recommended that you always turn on a device with your mobile phone connected to network, especially for the first time of device initialization.

Note: If you plan to initialize your device in an environment without mobile network, please make sure you have cached all necessary information in your mobile phone beforehand. For details, please read “[Help > Data Platform > Ecotopia App > Cache Management](#)” on the datacenter (https://www.ecotopiago.com/help/en/#/instruction/App/cache_setting).

(1) Authorize Bluetooth to Ecotopia App, and log in with your account.

(2) On Ecotopia App, tap  on top right to scan QR code on HUB, and follow the instructions to turn them on, and deliver the settings to the device.

Note: “Setting delivery” is an important step to initialize your device. By doing this, the device can obtain the fine settings that are suitable for each sub-model. When your App is connected to network, it will obtain the correct settings from the cloud server. Without network connection, the App will use the information you cached in your mobile phone.

Then, HUB will start to collect its own data, scan and communicate with Debut devices assigned to it, and transmit data automatically, following its settings.

Note: As HUB can be used both as a terminal and as a gateway, it has two groups of settings. The settings you see on App and data center are its terminal settings. Its gateway settings (such as the scanning intervals, data downloading intervals, device entry/exit monitoring and reporting intervals, beacon locating switch, etc.) is not configurable on data center or App at this moment. It can also be set to Super Mode so it can collect data for all users' devices.

If you want to know more or change the default gateway settings, you can always contact support@druid.tech.

Two Usage Scenarios

As Fixed Station

HUB can be fixed in a certain location to automatically scan for devices within its communication range, download data from them, deliver new settings to them, and monitor their entry/exit.

Below pictures show HUB deployment method. Use fasteners or tapes to fix HUB to a proper object.

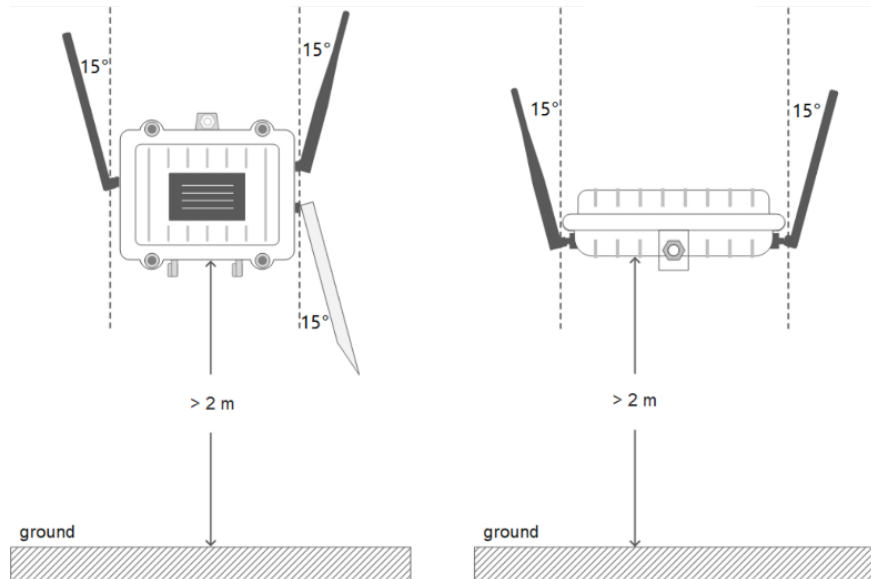

Note: For TAG G, use fastener or tapes to hang it to something like a branch. To achieve maximum communication range, it's suggested to deploy HUB or TAG G in an open space without obstacles (such as walls, woods, or hills), and lift it to at least 2m from the ground beneath.

If the place you plan to deploy HUB does not have network signals, HUB can still download data from other Debut devices, but will not be able to upload data to cloud server. In this case, you can visit HUB once in a while and use your Ecotopia App to download all data stored in HUB. When you come back to a place with network, you can upload those data via mobile network connection.

As Mobile Relay

As you know, a mobile phone can be used as a gateway for Debut devices, only with limited communication distance. But you can always use HUB as a relay to lengthen the communication distance to up to 1500 meters (depending on environment).

With HUB as a relay, you can connect your phone to devices remotely and perform real-time operations, such as showing all devices nearby on the phone screen, downloading their data immediately, changing their settings, or being guided to find a certain device.

Steps for using HUB as a relay:

- (1) Log in to your Ecotopia App, and make sure the HUB has been turned on.
- (2) Tap  on App, and all Debut devices under the account are shown.
- (3) Tap to choose one device or tap and hold to choose multiple devices, and then choose the operation you want. Your phone will automatically connect to the device via HUB if the device is out of the range of your phone.

When you're carrying HUB while walking/driving during fieldwork, please watch out and take care of yourself.

Recharging Hub

There are two ways to recharge the built-in battery of HUB:

- By power cable (provided along)
- By solar panel (provided along)

Note: TAG G is already with a solar panel. Its battery can be recharged by placing the device in direct sunlight.

Data Service Fee Management

Data service fee consumption of a device in each month is determined by its data service status during that month. To optimize the data service fees for your devices, it is important to manage their data service status based on your needs.

In addition, please keep your account balance positive to avoid disruptions to data services. To recharge your data service fee, please contact your sales representative for assistance.

For more info, please read "**Help > Data service status, data service items and pricing**" on Ecotopia data center.

SATISFACTION GUARANTEE

Druid Technology offers triple satisfaction guarantee to relieve you from any worries.

6-Month Return & Refund (customized products not included)

You can apply for return & refund within 6 months since the date of purchase if you are not satisfied with the device. You will cover data service fee incurred in the period.

Limitations: The device hasn't been deployed, altered or tampered with and should be without any cosmetic damages. It should function properly as remotely tested and confirmed by Druid.

1-Year Limited Warranty

Your device enjoys 1-year limited warranty since the date of purchase. During the period, Druid will repair or replace, depending on the actual case and technical feasibility, any defective devices. You need to return the device to Druid for service.

Limitations: Warranty does not apply to defects resulting from improper maintenance or use ^[1], physical damage, or operation outside environmental specifications.

Debut Renewal Plan (Optional)

Apart from return & refund and limited warranty, you can purchase Debut Renewal Plan as a lifetime insurance that offers you a new device without condition. You can also purchase renewal plan for the replaced new device. After the service is used, the status of old device will turn to *Terminated*.

^[1] Improper maintenance or use may cause permanent damage and affect warranty. Please read the following cautions carefully:

- Keep the surrounding environment temperature of the device under 60 °C in any circumstances. Otherwise, permanent damage may happen to the device;
- Keep the device away from magnetic field or electric field (for example, a transformer);
- Take proper protection measures to prevent the device from falling on hard surfaces;
- Don't dismantle, alter or tamper with the device.
- Be sure to charge the battery periodically (at least 1 day every 2 weeks for models like ULTRA and NANO P1 lite, every 4 weeks for models like NANO/MINI/INTERREX/FLEX II, and every 8~12 weeks for models like FLEX II Argos/FLEX II MAX/FLEX/LEGO, etc.). After charging, click the Intelink icon on Ecotopia App and wait for the devices to highlight. If the battery is over 4V, store the devices. No need to turn them on or change data service status. This step is important as it records maintenance for warranty coverage.

When you dispose your device and/or other batteries, make sure that it is done sustainably.